

SANYO

INSTRUCTION MANUAL

DC-MP9500

Micro Component System

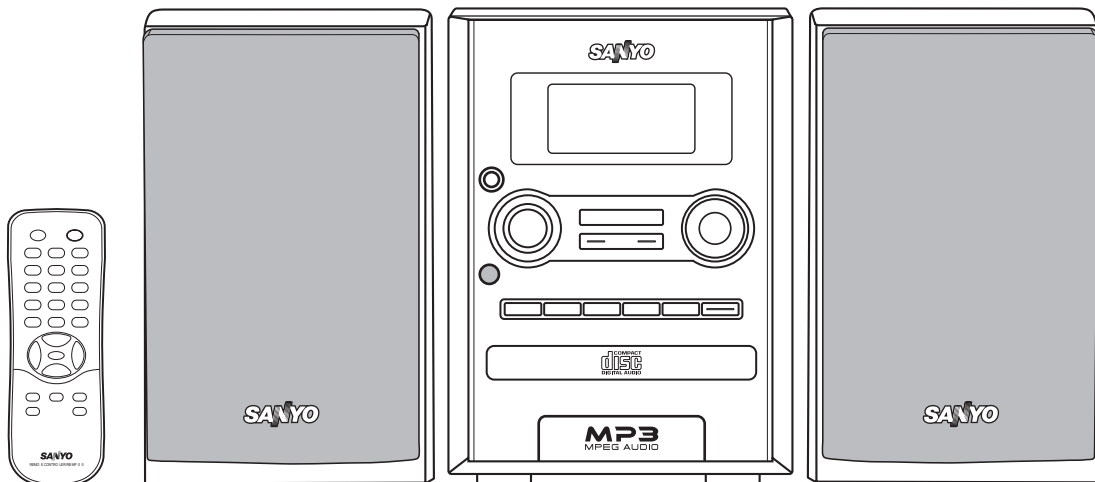

PRECAUTIONS

CAUTION

THIS PRODUCT CONTAINS A LOW POWER LASER DEVICE. TO ENSURE CONTINUED SAFETY DO NOT REMOVE ANY COVERS OR ATTEMPT TO GAIN ACCESS TO THE INSIDE OF THE PRODUCT. REFER ALL SERVICING TO QUALIFIED PERSONNEL.

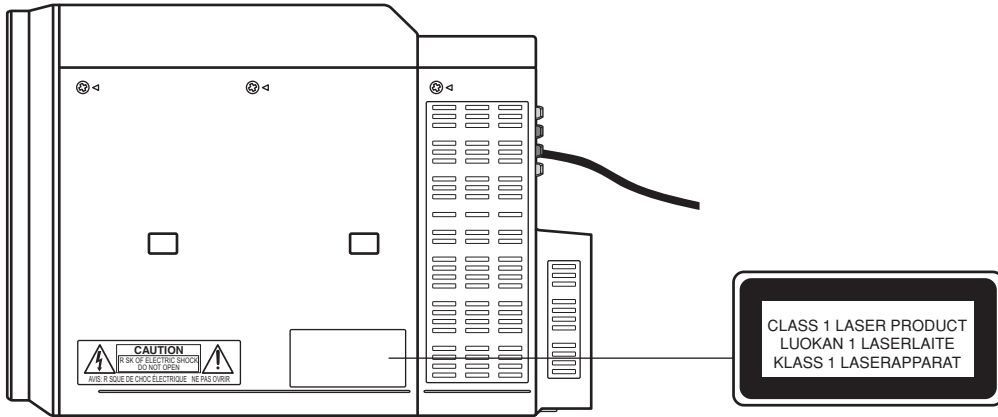

- The apparatus shall not be exposed to dripping or splashing.
- Do not use where there are extremes of temperature (below 5°C or exceeding 35°C), or where direct sunlight may strike it.
- Because of the CD player's extremely low noise and wide dynamic range, there might be a tendency to set the volume on the amplifier unnecessarily high. Doing so may produce an excessively large output from the amplifier which could damage your speakers.
- Sudden changes in the ambient temperature may cause condensation to form on the optical lens inside the unit. If this happens, take out the disc, leave the unit for about 1 hour, and then proceed to operate.
- The system's speakers use powerful magnets. Do not place time-pieces, credit cards, cassette tapes or video tapes, etc. near the speakers.
- Do not install this equipment in a confined space, such as a book case or built in cabinet.
- No object filled with liquids, such as vase, shall be placed on the apparatus.
- The rating label is located on the bottom of the unit.

IMPORTANT

If the plug supplied with this equipment is not suitable for the socket outlets in your home it should be cut off and replaced with the correct type.

Disposal of Plug

If the non rewirable plug is to be cut off, the removed plug should be disposed of carefully as there is a shock hazard should the plug be inserted into a live socket.

Replacing Fuse

The detachable fuse cover must be replaced after changing the fuse. Only a 3A fuse should be used and should comply with BS1362 and should carry the ASTA mark .

The wires in the mains lead are coloured in accordance with the following code:

Blue	Neutral
Brown	Live

The wires in the mains lead must be connected to the terminals in the plug as follows:

Wire colour	Plug terminal marking
Blue	N or Black or Blue
Brown	L or Red or Brown

Do not connect either wire to the earth terminal.

If the mains plug contains a fuse this should be 3A, if a plug without a fuse is used the distribution board fuse should not be greater than 5A.

The unit is not disconnected from the mains unless it is unplugged from the AC outlet.

CONNECTIONS

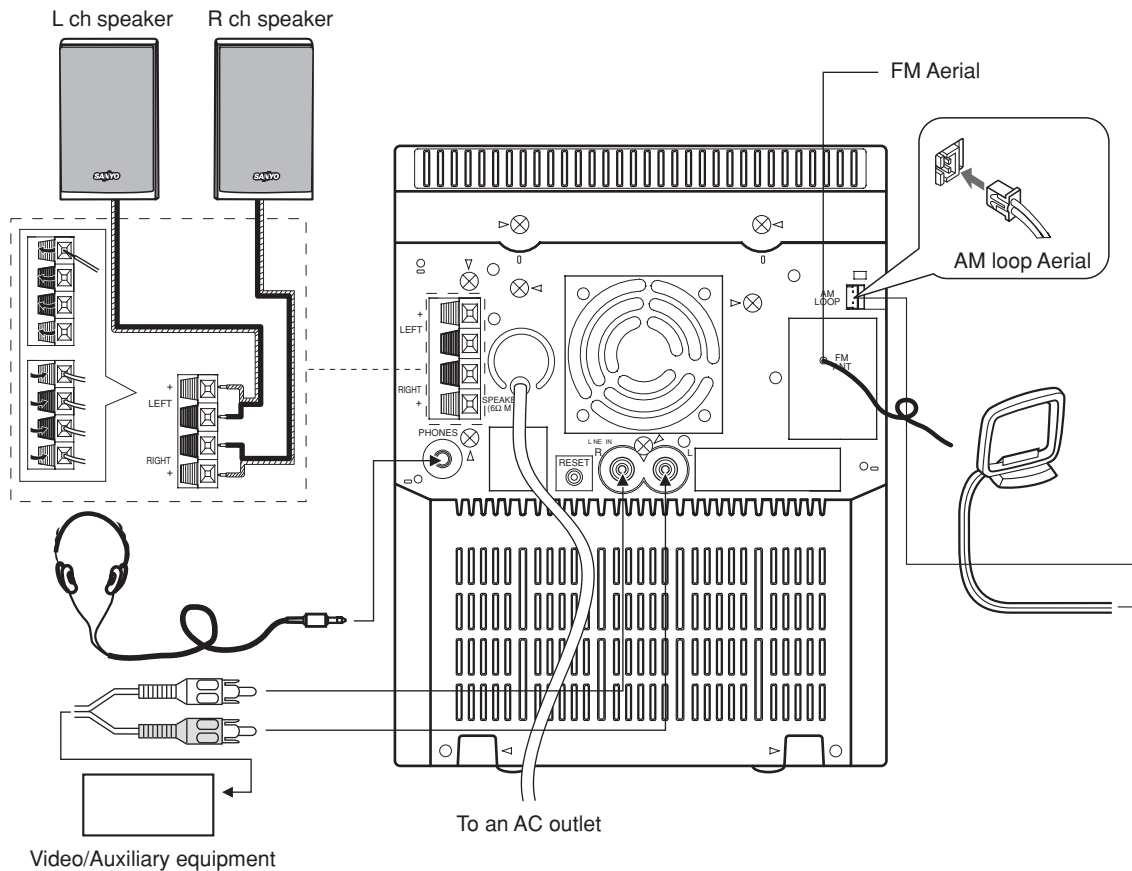

Note:

- Do not connect the mains lead to an AC outlet until all connections have been made.
- The system is not completely disconnected from the mains when the ⏻/ON button is set to the ⏻ position.

Speakers

Connect the connector of the left speaker lead to the "L" SPEAKERS socket and the connector of the right speaker lead to the "R" socket. If you have difficulty inserting the speaker lead connector, turn it over and reinsert it. When connecting the speakers, make sure that + and - polarities are matched properly. Otherwise, the sound may appear to be lacking in the bass range and stability. Connect the red speaker wire to the red terminal + and the black wire to the black terminal -.

FM Aerial

FM indoor aerial is sufficient to receive broadcasts. Extend the aerial wire as straight as possible and, while listening to the sound from the system, secure it in a position which yields minimal distortion and noise.

AM Loop Aerial

Assemble the loop aerial as shown in figure.

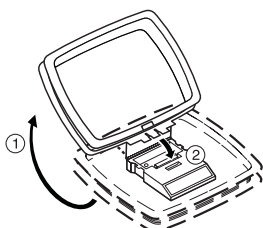

Unwind the aerial wires, then connect them to the AM LOOP terminals. Place the loop aerial in a position which yields the best AM reception, or attach it to a wall or other surface as shown in figure.

Note:

To minimize noise, the speaker, mains and any other leads should not come close to the indoor or external aerial lead and AM loop aerial. Do not place the aerial leads close to the system.

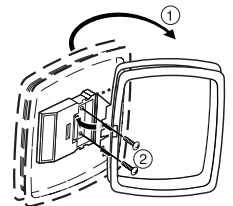

Screws (not supplied)

Headphones

Connect stereo headphones (not supplied) to the PHONES socket (rear of the unit) for monitoring or for private listening. The speakers are automatically disconnected when headphones are connected.

Video/Auxillary equipment

Connect audio leads (not supplied) from the audio output socket of a video/auxiliary equipment to the LINE IN sockets.

CONTROLS

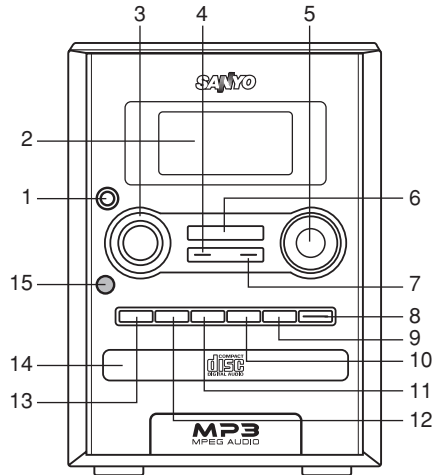

1. Power button (ON/OFF)
2. Display
3. Control panel
 - ▶/|| : CD play/pause button
 - ◀◀/ - , + / ▶▶ : Skip/search/tuning/file select buttons
 - : Stop button
4. Tuner function/band select button (TUNER/BAND)
5. Volume control button (VOLUME)
6. Function select button (FUNCTION)
7. Memory button (MEMORY)
8. Disc tray open/close button (OPEN/CLOSE)
9. FM mode/Display button (FM MODE/DISPLAY)
10. Random play button (RANDOM)
11. Repeat play button (REPEAT)
12. Clock/timer button (CLOCK/TIMER)
13. Tuner preset/Folder select button (TUNER PRESET/ FOLDER SELECT)
14. Disc tray
15. Remote sensor (IR)

REMOTE CONTROL

Controls

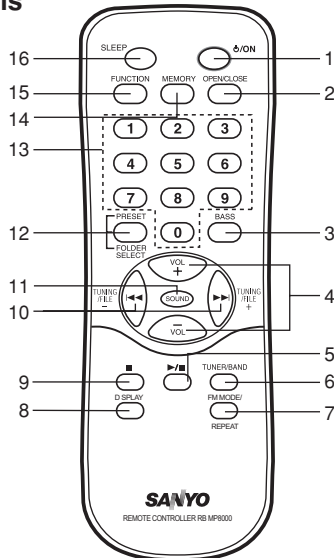

1. Power button (ON/OFF)
2. Disc tray open/close button (OPEN/CLOSE)
3. Bass expander button (BASS)
4. Volume control buttons (VOL -, +)
5. CD play/pause button (▶/||)
6. Tuner function/band select button (TUNER/BAND)
7. FM mode/Repeat button (FM MODE/REPEAT)
8. Display button (DISPLAY)
9. Stop button (■)
10. Skip/search/tuning/file select buttons (◀◀, - TUNING/FILE +, ▶▶)
11. Sound preset button (SOUND)
12. Preset/folder select button (PRESET/FOLDER SELECT)
13. Number buttons (1-9, 0)
14. Memory button (MEMORY)
15. Function button (FUNCTION)
16. Sleep button (SLEEP)

Number buttons (1-9, 0)

These buttons are used to select the track numbers on a disc or preset radio stations. If the function is "CD", the buttons select the track numbers on a disc. If the function is "TUNER", the buttons select preset radio stations. With any other function, the buttons will not function.

Inserting batteries

1

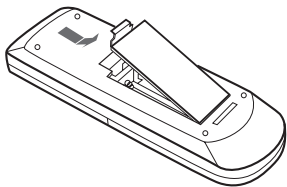

2

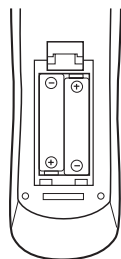

Two R03/AAA batteries (not supplied)

Remote control range

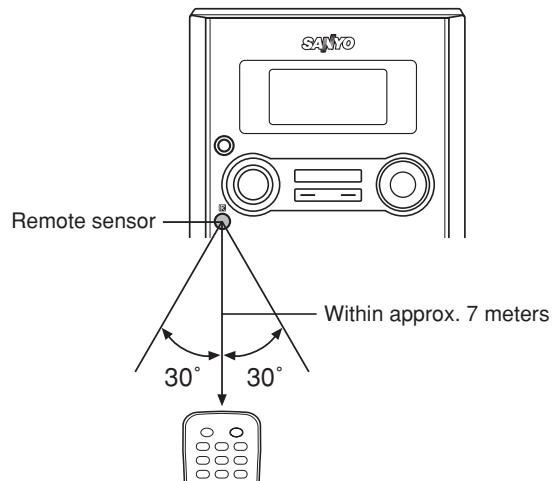

Note:

Always remove batteries if the remote control is not to be used for a month or more. Batteries left in the unit may leak and cause damage.

The buttons on the remote control perform similar functions to similarly marked buttons on the front panel.

ADJUSTING THE CLOCK (Main unit only)

Example: To set "6:30".

Turn the power off before setting. If this is the first time for setting, "0:00" display blinks.

1. Press the CLOCK/TIMER button for more than 3 seconds, "⊖" blinks on the display.



2. Press the MEMORY button. The "hour" section and "⊖" blinks.



3. Turn the VOLUME control to set the "hour" section.

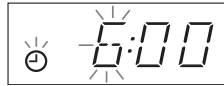

4. Press the MEMORY button to finish the hour setting, the "minute" section and "⊖" blinks at the same time.



5. Turn the VOLUME control to set the "minute" section.

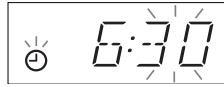

6. Press the MEMORY button to finish all settings and the clock starts.

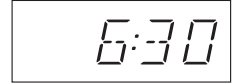

- The time can be set accurately by pressing the MEMORY button when a time signal is heard.

Note:

- To display the clock during operation, press the CLOCK/TIMER button briefly. After a few seconds, the original display returns.
- If a power failure occurs or the mains lead is disconnected, the clock display blinks. Reset the time again.

Changing the clock to the 12-hour display (Using the main unit)

Example: 13:30 → PM1:30

1. Press the ⏻/ON button to turn the power off and present time display.
 2. While clock is displaying, press the MEMORY button on the main unit and hold it, then press the TUNER PRESET/FOLDER SELECT button on the main unit.
- To return the original setting, repeat the steps above.

BEFORE OPERATION

Turning the power on and off

- Press the ⏻/ON button to turn on the unit, the display lights and "WELCOME" will appear for several seconds.
- To turn the power off, press the ⏻/ON button again, "GOOD BYE" will appear for several seconds.
- When the unit is in standby, press the CLOCK/TIMER button to select demonstration mode or clock display mode only.
- When the mains lead is connected to the AC outlet, the unit will respond to commands from remote control.

Direct start function

If the following buttons are pressed when the unit is in standby, the unit turns on automatically and the function is set.

CD section ▶/II, TUNER/BAND
Remote control ▶/II, TUNER/BAND

Selecting the function

Press the FUNCTION button to select the desired function. Each time the button is pressed, the display changes as follows:

CD → TUNER → LINE → CD → ...

The function is automatically selected when CD play started or the TUNER/BAND button has been pressed.

When the function selection is changed, CD play is automatically stopped.

Adjusting the volume

Turn the VOLUME control or press the VOL - or + button on the remote control to adjust the volume, the volume level appears on the display. (VOL MIN, 1~39, MAX)

Bass expander system (Remote control only)

Press the BASS button to enhance the bass sound, "BASS" appears on the display.

Press the BASS button again to close the bass sound, "BASS" disappears on the display.

Selecting the sound mode (Remote control only)

Press the SOUND button to select the sound mode matching the music below:

POP: Pops, etc.
CLASSIC: Classical music, etc.
ROCK: Rock music, etc.
JAZZ: Jazz, etc.

WHAT TO DO IF ...

If the operation of the unit or display is not normal,

1. Disconnect the main lead.
2. Press the RESET hole (rear of the unit) for at least 30 seconds.
3. Connect the main lead.
4. Resume operations.

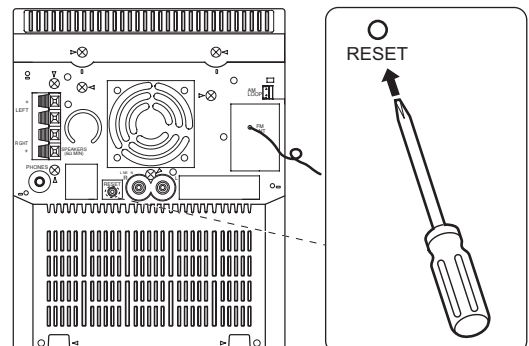

CD PLAY

Use compact discs bearing the symbol shown. In addition to conventional 12 cm CDs, this system can be used to play 8 cm CDs without an adapter.



- This unit can play back the CD-R/RW that have recorded music data as well. However, some CD-R/RWs cannot be played back depending on the recording conditions.
- The CD-R/RW cannot be recorded in this unit.

1. Press the FUNCTION button to select CD function.
2. Press the OPEN/CLOSE button, disc tray slides out, "OPEN" appears.
3. Place the disc with the label facing up on the disc tray. (Place only one disc at a time.)

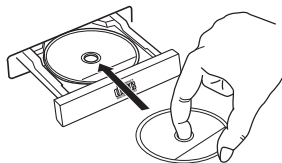

4. Press the OPEN/CLOSE button again to close the disc tray. "CLOSE" appears briefly, then the total number of tracks and the total playing time on the disc appears.

5. Press the ►/|| button. Play starts from the first track. The current track number and elapsed playing time are displayed.

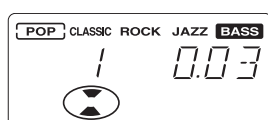

6. Press the ■ button to end disc play. When the last track has been played, the player stops automatically.

Note:

- If the disc is loaded with the label side downward, or if a badly scratched disc is loaded, "NO DISC" or "UNDISC" appears on the display. If this occurs, load the disc correctly or replace the damaged disc.

Notes on handling compact discs

- Do not expose the disc to direct sunlight, high humidity or high temperatures for extended periods of time.
- Discs should be returned to their cases after use.
- Do not apply paper or write anything on the disc surface.
- Handle the disc by its edge. Do not touch the playing surface (glossy side).
- Fingerprints and dust should be carefully wiped off the playing surface of the disc with a soft cloth.
- Wipe in a straight motion from the centre to the outside of the disc.
- Never use chemicals such as record cleaning sprays, antistatic sprays or fluids, benzene or thinner to clean compact discs.

To start play from the desired track

Select the track by using the ◀◀ or ▶▶ button, then press the ►/|| button.

Using the remote control

For normal music CD:

Press two number buttons within 4 seconds.

Example:

To select No. 3, press 0, 3.

To select No. 10, press 1, 0.

To select No. 32, press 3, 2.

For MP3 CD:

Press three number buttons within 4 seconds.

Example:

To select No. 3, press 0, 0, 3.

To select No. 10, press 0, 1, then 0.

To select No. 125, press 1, 2, then 5.

Temporarily stopping play

Press the ►/|| button. To resume play, press the ►/|| button again.

Skip play

To skip to track 6 while track 3 is playing, press the ▶▶ button repeatedly until "6" appears (in the track section) on the display. To skip back to track 3 while track 6 is playing, press the ◀◀ button repeatedly until "3" appears.

- The number buttons on the remote control can also be used for skip play. To skip to track 6 while one track is playing, press 0, then 6 (for normal music CD), or 0, 0, 6 (for MP3 CD).

Search play (forward/reverse)

If the ◀◀ or ▶▶ button is pressed during play, the player will search at high speed in the forward or reverse direction while the button is being pressed. When the button is released, normal play will continue.

Repeat play

Press the REPEAT button (or the FM MODE/REPEAT button on the remote control) before or during play. Press the button once, "1 REPEAT" displays, repeat single track. Press the button twice, "ALL REPEAT" keeps displaying, the unit will repeat all tracks or all programmed tracks.

To cancel repeat play, press this button again till "1 REPEAT" or "ALL REPEAT" disappears.

Random play (Main unit only)

Press the RANDOM button, the player will automatically play disc optionally, "RANDOM" will appear on the display screen.

Note:

- Press the ■ button to cancel random play.
- Random play will not function during programme play.
- If chosen random play when using MP3 disc, folder select function can't work.

Programmed play

Up to 24 tracks on a disc can be programmed for play in any order.

- First, select CD function and load a disc that you want to programme.
- The tracks must be programmed in the stop mode.
- The same track can be programmed more than once.

1. Press the MEMORY button in the stop mode, "PROGRAM" appears and blinks.

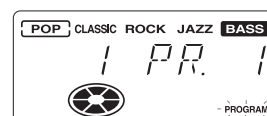

2. Press the ◀◀ or ▶▶ button to select a track.

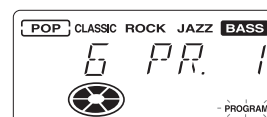

- The number buttons on the remote control can also be used. In this example, press 0, 6.

3. Press the MEMORY button.

4. Repeat steps 2 - 3 above to programme additional tracks.

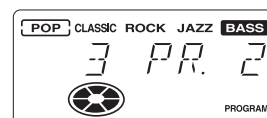

5. Press the ►/|| button to start programmed play.

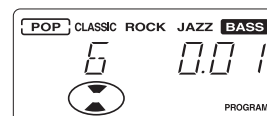

- When all programmed tracks have been played, the player stops automatically.
- The programme contents are retained in memory.
- Any attempt to programme more than 24 tracks will result in "FULL" being displayed and discontinuation of the programming.
- The programme contents are retained even if the function selection is changed. Press the MEMORY button after selecting CD function, the programmed contents appear.

Checking the programme

Each time the MEMORY button is pressed in the stop mode, the programmed details sequentially appear on the display.

Changing a programme

To change a track

1. In the stop mode, press the MEMORY button repeatedly until the track number to be replaced is displayed.
2. Press the ◀◀ or ▶▶ button to select a track as explained above.
3. Press the MEMORY button.

Note:

- Programmed details cannot be partially deleted or inserted.

To add a new track to a programme

1. In the stop mode, press the MEMORY button repeatedly till “- - - - -” appears.
2. Press the ◀◀ or ▶▶ button to select a track as explained above.
3. Press the MEMORY button.

Cancel programme

- Press the ■ button once in the stop mode to cancel programmed play.
- After opening the disc tray, the programme contents will be cleared away.

MP3 CD PLAY

This unit can play back the CD-R/RW that has recorded music data or MP3 files. Before playing back MP3 CD, please read the following.

MP3 CD information

- MP3 CD is the disc that standardized by ISO9660, its file name must have the extension letters, “.MP3” or “.mp3”.
- Standard, sampling frequency, and the bit rate: MPEG-1 Audio, layer 3
32kHz, 44.1kHz, 48kHz
32kbps - 320kbps (constant bit rate or variable bit rate)
- The recommend recording setting for a high-quality sound is 44.1kHz of sampling frequency and 128kbps of constant bit rate.
- The directory and file names of the MP3 CD must be corresponded to the ISO standardized files.
- Single-session disc can be played back.
- This unit can recognize up to 250 folders or 500 files per disc. The CD disc with 251 folders or 501 files and over is not available to this unit.
- This unit can recognize up to 8 directory trees per disc.
- MP3 CD may not be played in the recorded order.
- Music section in “CD Extra” can be played back, not Data section.
- “Mixed CD” can’t be played back.

Notes on disc writing method

There are three basic methods for writing to a CD: “Track-at-Once”, “Disc-at-Once”, and “Packet Writing”.

Music files recorded by “Track-at-Once” or “Disc-at-Once” can be played back on this unit. (Note: The unit can’t play back the music files added with “Track-at-Once”.)

Music files recorded by “Packet Writing” can’t be played back.

Limitations on display

Available letters for display are the following: capital alphabets of A through Z, numbers of 0 through 9 and _ (underline).

MP3 CD directory sample

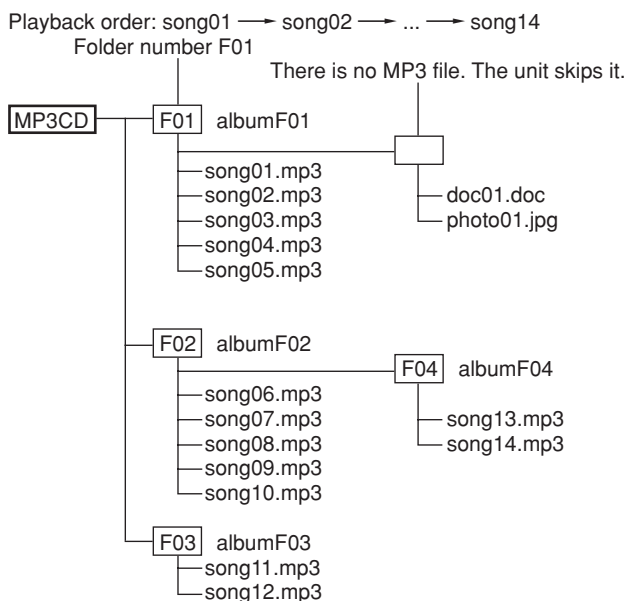

Note:

- Some MP3 CDs can't be played back depending on the recording conditions.
- The CD-R/RW that has no music data or non-MP3 files can't be played back.
- Do not make an empty folder. It may not work correctly.
- In this model, recommend recording setting is 44.1kHz of the sample frequency and 128kbps of constant bit rate. If files are recorded in other bit rate (for example: 320kbps) or in variable bit rate, track-jump may sometimes happen according to recording conditions.

MP3 CD Play

1. Turn the power on and choose CD function.
2. Load the MP3 CD.
The total number of folders and tracks appear on the display.

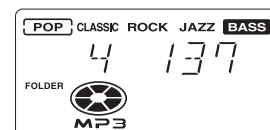

3. Press the TUNER PRESET/FOLDER SELECT button (or the PRESET/FOLDER SELECT button on the remote control) to select the desired folder.

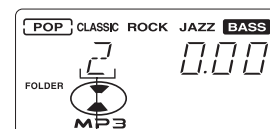

Desired folder

4. Press the ◀◀ or ▶▶ button to select the desired track.
5. Press the ▶/|| button to start play, the track number and elapsed playing time will display on the screen.

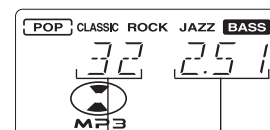

Track number

Elapsed playing time

Display selection

The ID3-Tag is an information field for MP3. Music title, artist name and album name can be stored into the tag. This unit shows these information. Press the FM MODE/DISPLAY button on the main unit (or the DISPLAY button on the remote control) during play.

- Each time the button is pressed, the display changes in the following sequence.
Folder name (Album name)/File name (Music name)
Music information: music title
Music information: artist name
Music information: album name
- If no music information is stored, “NO INFO” appears. Press this button again, the track number and elapsed playing time appear.

Folder selection

Example: There are 3 folders in MP3 CD.

- In stop mode, press the TUNER PRESET/FOLDER SELECT button (or the PRESET/FOLDER SELECT button on the remote control) repeatedly to select desired folder number. The folder number will display in recycle:
1 → 2 → 3 → 1 → 2 → 3 → 1 → ...
When desired folder is selected, press the ▶/|| button to start play from the first track of this folder.
- In playing mode, do the same operation and the same folder display order in turn. But when the last folder is in, other folders cannot be selected in recycle order. Press the ■ button to go into stop mode.
- After selecting the desired folder in the playing mode, the unit will play the first track in it.

LISTENING TO THE RADIO

Before use

When the unit is shipped from the factory, its AM frequency band is set as "522 ~ 1611 kHz (in 9 kHz steps)".

If your local AM broadcast system is organized in 10 kHz steps, change the frequency band to "520 ~ 1610 kHz (in 10 kHz steps)" as follows.

1. Press the TUNER/BAND button to select AM.
2. Press the **■** and the RANDOM buttons on the main unit at the same time, the frequency band will be changed to "520 ~ 1610 kHz (in 10 kHz steps)".

Note:

To return the original setting, repeat the steps above.

Automatic/manual tuning

1. Press the TUNER/BAND button to select FM or AM.

Automatic tuning

- Press the **◀◀** or **▶▶** button for at least 1 second to tune in a station. The unit will scan up or down the band and receive the next receivable station. Press the button again to continue.

Manual tuning

- Press the **◀◀** or **▶▶** button briefly until the desired frequency is displayed.

To receive FM stereo broadcasts

"STEREO" appears when an FM stereo broadcast is received under stereo receiving mode.

- If the signal from an FM stereo station is weak and reception is poor, "STEREO" blinks or disappears. Press the FM MODE/DISPLAY button (or the FM MODE/REPEAT button on the remote control) to change to the monaural mode. The reception may be improved, but the sound will be monaural.

To preset stations

Up to 24 stations for FM band, 12 stations for AM band can be preset.

Automatic presetting (APT)

1. Press the TUNER/BAND button to select AM or FM.
2. Press the MEMORY button for at least 3 seconds, "PROGRAM" blinks. The automatic tuning mode is set and automatic presetting begins from the low end of the band.

When 24 FM or 12 AM stations have been preset or the high end of the band is reached, automatic presetting stops, "PROGRAM" disappears and the station memorized on channel 1 will be heard.

Note:

If APT is activated, all previously programmed stations of the band will be cleared and new stations will be programmed.

Manual presetting

1. Tune in the station to be preset as described above.
2. Press the MEMORY button. "PROGRAM" appears and blinks.

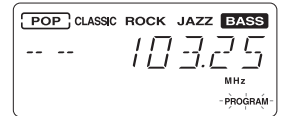

3. While "PROGRAM" is blinking, press the TUNER PRESET/FOLDER SELECT button on the main unit (or the PRESET/FOLDER SELECT button on the remote control) to select the channel to be preset.

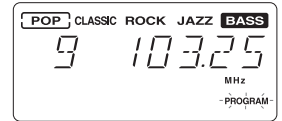

- The number buttons on the remote control can be used to preset the station directly. Press two numbers, in this example, press 0, then 9, then step 4 is omitted.

4. While "PROGRAM" is blinking, press MEMORY button and "PROGRAM" disappears.

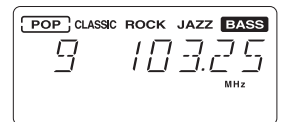

- In this example, "103.25MHz" FM station is preset on FM channel 9.

5. Repeat steps above to add more preset stations.
 - When presetting a new station, the previous preset station is cleared.

Listening to preset stations

1. Press the TUNER/BAND button to select FM or AM.
2. Press the TUNER PRESET/FOLDER SELECT button on the main unit (or the PRESET/FOLDER SELECT button on the remote control) to select the desired channel number.
 - The number buttons on the remote control can also be used. Press two number buttons within 2 seconds.

When beat interference is heard

Beat (a high-pitched noise) may sometimes be heard during listening the radio broadcasts. If this occurs,

1. Press the MEMORY button.
2. While "PROGRAM" is blinking, press the **■** button on the main unit to select "bc-A" or "bc-B". Select the setting that gives the best result.

LISTENING TO OTHER SOURCES

1. Press the FUNCTION button to select "LINE".

2. Follow the instructions supplied with the other equipment.

TIMER OPERATION

Using the timer

Set the on and off times, and function to be used. Operation will start with the selected function at the on time.

The power will be switched off at the off time.

The timer will function every day unless it is released.

Before Operation

Make absolutely sure that the clock is set to the correct time before setting the timer.

- Prepare the sources to be used.
 - Adjust the tuner or band of radio if choose TUNER function.
 - Place the disc in advance if choose CD function.
- Adjust the volume to the suitable level for listening.

Example: Waking up 7:30 every day, listening to the radio till 8:15.

1. Press the FUNCTION button to select the desired preset function and set the desired volume level for timer operation.

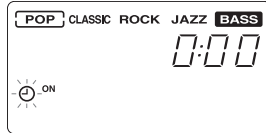

2. Press the CLOCK/TIMER button for at least 2 seconds, the previous timer ON time appears and "⊖" blinks.

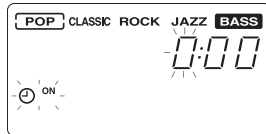

3. Press the MEMORY button, the "hour" and "⊖ ON" blink.

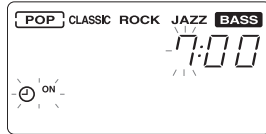

4. Turn the VOLUME control to set the "hour".

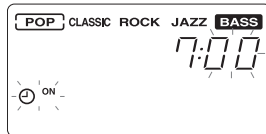

5. Press the MEMORY button, the "minute" blinks.

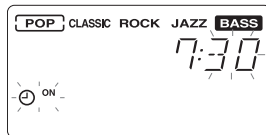

6. Turn the VOLUME control to set the "minute".

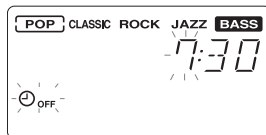

7. Press the MEMORY button to confirm the "minute" and finish ON time setting. "⊖ OFF" and "hour" appear and blink.

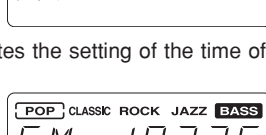

8. Repeat steps 4 - 7 above. This completes the setting of the time off timer.

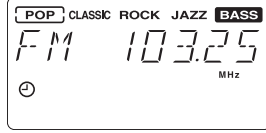

9. Press the MEMORY button, the original display and "⊖" appear.

10. Press the ⊖/ON button to switch off the power.

"⊖" remains light.

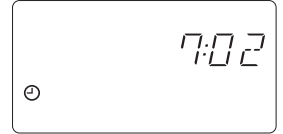

Note:

- When the timer on time arrives, the power turns on and start the pre-set function.
- "⊖" blinks while the timer operation is engaged.
- The timer will be set to the standby mode if press the ⊖/ON button when the timer in operating.

To check the timer settings

Turn on the power. Press the CLOCK/TIMER button once, current time appears. Then press the CLOCK/TIMER button about 3 seconds, timer on time appears, then press the button repeatedly, the timer setting are displayed in the following order.

- Timer off time.
- Original preset function.
- Original display returns.

To change the timer settings

1. Press the CLOCK/TIMER button to select the setting to be changed.
2. Press the MEMORY button so that the display blinks.
3. Change the setting as explained above.

To release the timer

Press the CLOCK/TIMER button repeatedly till "⊖" display disappears.

To set the timer again with the same settings

1. Press the CLOCK/TIMER button repeatedly to display "⊖".
2. Press the ⊖/ON button to switch off the power.

USING THE SLEEP TIMER (Remote control only)

The sleep timer automatically switches off the power after a preset time has elapsed. There are 12 time periods available: 120, 110, 100, 90, 80, 70, 60, 50, 40, 30, 20, and 10 minutes. Press the SLEEP button repeatedly to select a time period.

Example: Select the sleep time of 60 minutes.

Press the SLEEP button to choose sleep time of 60 minutes, "SLEEP" and the sleep time of 60 will blink, after several seconds the original display returns, "SLEEP" remains blink till power off.

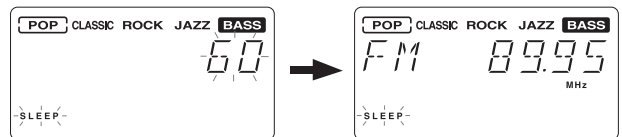

- If you want to examine the remain sleep time during sleep timer operation, press SLEEP button once, the remain time will display.
- To release the sleep timer, press the SLEEP button repeatedly till "SLEEP" disappears.
- The sleep timer will clear automatically when the power turned off.

MAINTENANCE

Cleaning the unit

Clean the outside of the unit with a clean soft cloth, moistened with luke-warm water. Do not use benzene, thinner or alcohol since they will mar the finish of the surfaces.

SPECIFICATIONS

CD player

Type: 2-channel stereo
Pick-up: Optical 3-beam semiconductor laser
Laser output: 0.6mW (Maximum continuous wave)
Wave length: 790nm
Wow/flutter: Below measurable limits

Tuner

Reception frequency:
FM: 87.5 ~ 108.0MHz
AM: 522 ~ 1611kHz (9kHz steps)
520 ~ 1610kHz (10kHz steps)

General

Output Power: 40 W X 2 (at 6 ohms, 10% distortion)
Input: LINE IN: 900mV/50K Ω
Outputs: SPEAKER: 6 ohms
PHONES: 8 ~ 32 ohms

Power requirement: AC 230V, 50Hz
Power consumption: 70 W
Dimensions: 165(W) x 205(H) x 305(D) mm
Weight: 4.5kg

Speaker systems

Type: Bass reflex
Unit used: Woofer: 12 cm cone type
Tweeter: 2.5 cm balanced driver
Maximum power-handling capacity: 80W (peak)
Nominal impedance: 6 ohms
Dimensions: 154(W) x 208(H) x 192(D) mm
Weight: 1.8kg (per speaker)

Specifications subject to change without notice.



GUARANTEE TO CUSTOMER

Sanyo Europe Ltd. (the Company) guarantees to the initial retail purchaser that if this equipment is or becomes defective and that, in the opinion of the Company, the defect is due to faulty material or workmanship the Company will, for a period of 12 calendar months from the date of sale to the original purchaser repair or replace, at its sole option, free of charge, any such defective component part of the equipment, always provided that: -

1. The equipment has at all times been used in accordance with the operating instructions issued by the Company, and has not been connected to an electrical mains supply for which it has not been adjusted.
2. Accidental damage, or damage caused by negligence or misuse by the user, including leakage from exhausted batteries, is specifically excluded.
3. Unauthorised repairs, or any modification to the equipment which has not been expressly approved by the Company, shall render this guarantee null and void.
4. Failure due to fair wear and tear of any item, such as batteries, record playing styli, and tape recording, playback and erase heads is specifically excluded.

This guarantee is not transferable and is only applicable within the United Kingdom (and the Republic of Ireland). Nothing in this express guarantee affects the statutory rights available to the purchaser of this equipment.

Note: This guarantee supersedes any other form of guarantee that may inadvertently have been enclosed with or attached to the product. (August 1978).

Dear Customer

Thank you for buying Sanyo. This equipment should give you many years of pleasure and faithful service but in the event that a fault occurs, the following notes for your guidance may be helpful:-

1. PLEASE RETAIN YOUR PURCHASE RECEIPT WHICH WILL BE REQUIRED FOR SERVICE DURING GUARANTEE.
2. If your Sanyo equipment proves faulty during the period of guarantee, take it or send it back to the dealer who originally supplied it together with this guarantee and the proof of purchase. We have made arrangements with our approved dealers under which they will carry out in-guarantee service repairs on our behalf. In this way, we hope to reduce to a minimum the amount of time you will be without your equipment.
3. If for some reason it is impossible to return the equipment to the original supplier, please contact our Consumer Relations Department at the address below for further advice.
4. Should the equipment require servicing after the expiry of the guarantee period, take or send it to the original supplier or any other Sanyo dealer. He will be pleased to give you a quotation for the repair. If you are in any doubt about what to do, write to us at the address below or telephone:

**Consumer Relations Department,
Sanyo Europe Ltd.,
18 Colonial Way, Watford
WD24 4PT
Tel: Watford 246363**

R6